

42" Ext. Box Handle 4-781

Schematic #	Part #	Description
1	8400	Trigger Sleeve
2	8186	Shoulder Screw
3	7015	6-32 Lock Nut
4	8510	Trigger Spring
5	8183	Trigger
6	8405	Ext. Brake Handle Assembly
7	8302	10-32 Lock Nut
8	8210	Connecting Rod Pin
9	8215	Brake Handle Plastic Bushing
10	8407	Screw
11	8421	Top Rod 42"
12	8431	42" Gray Inner Tube
13	8435	Screw
14	8705	Big Bushing
15	8706	#9 Washer
16	9218	Inner Spring
17	8511	Brake Mechanism
18	8409	Screw
19	8518	Inner Casing
20	8517	Pin
21	8441	42" Bottom Rod
22	9212	Ext. Box Handle Head
23	7063	Bearing
24	8700	Set Screw
25	9211	Large Pivot Pin
26	9208	Connector Plate
27	8515	Plastic Bearing
28	9903	Head Connector
29	9904	Small Pivot Pin
30	8516	Plastic Bearing
31	7701	42" Red Ext. Handle Tube
32	8288	8-32 Lock Nut
33	8276	8-32 X 1/2", BHC Screw

LEVEL 5

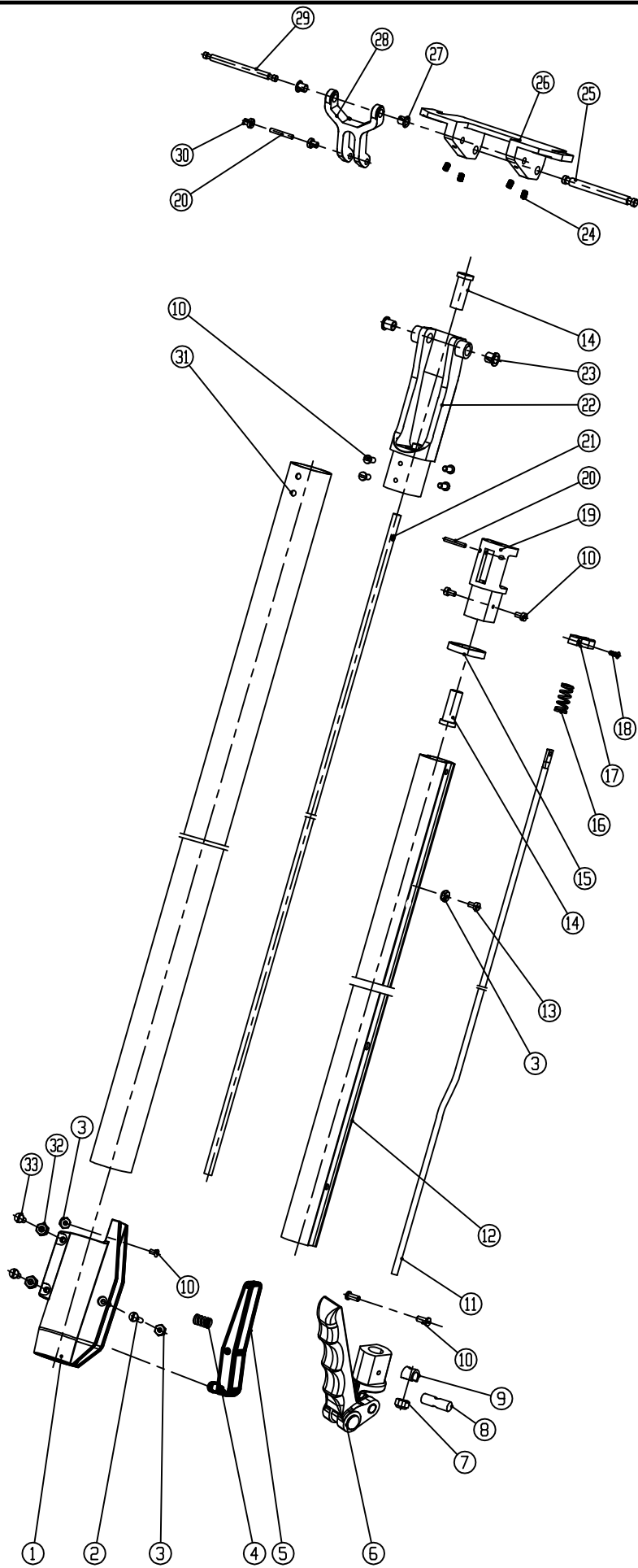

4-781 Ext Box Handle